

A = with ring – avec bague – mit Ring – con arillo – med ring

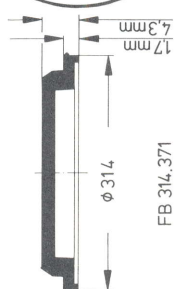

FB 314.371

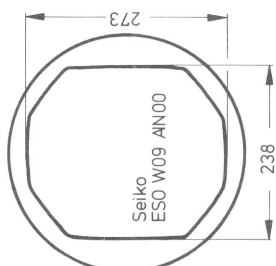
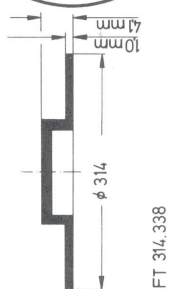
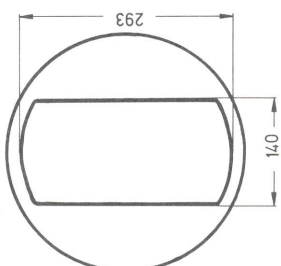

FT 314.338

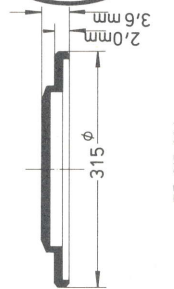
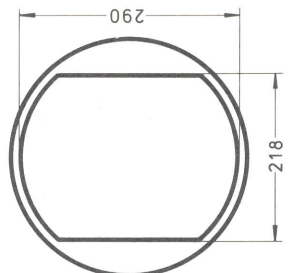

FT 315.334

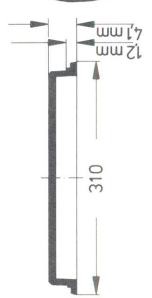
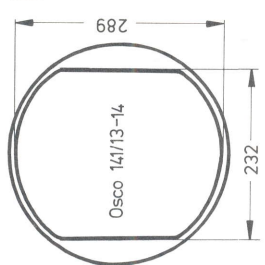

FT 310.382

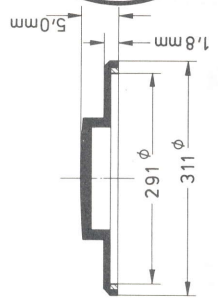
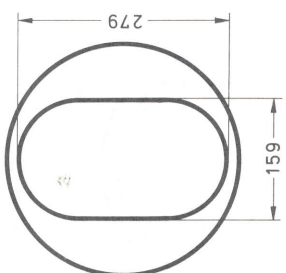

FTA 311.775

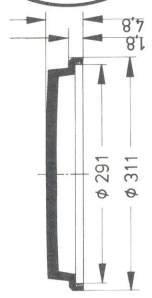
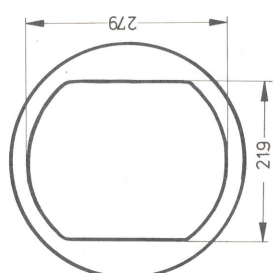

FTA 311.796

FT ↓

↓

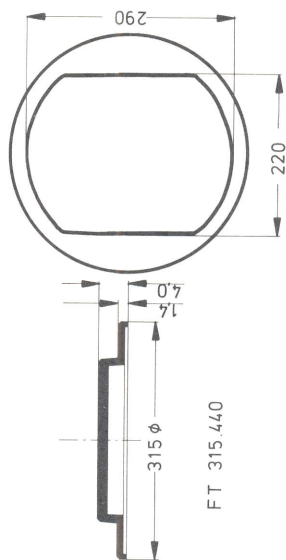

FT 315.440

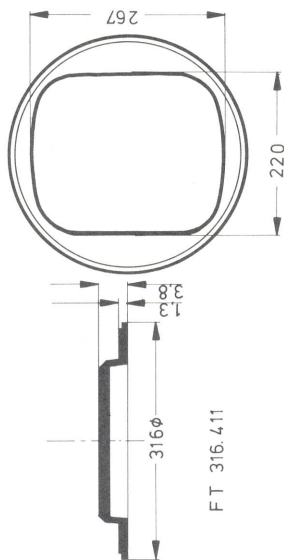

FT 316.411

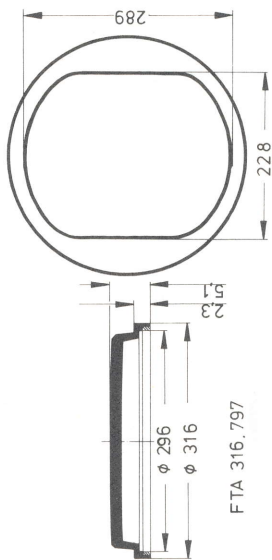

FTA 316.797

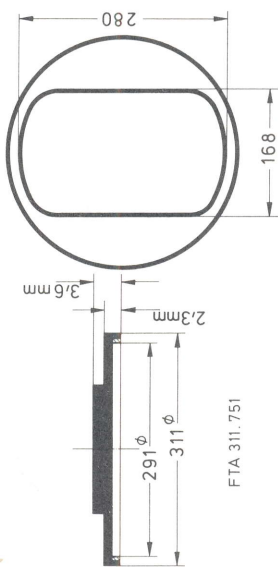

FTA 311.751

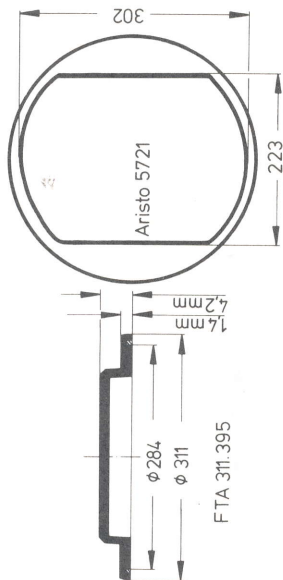

FTA 311.395

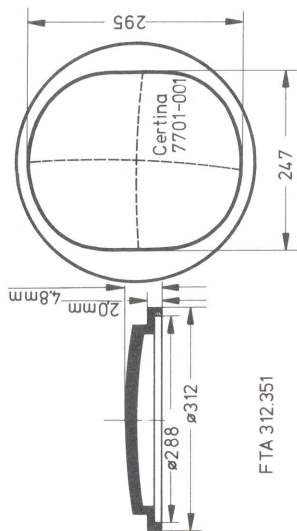

FTA 312.351

A = with ring – avec bague – mit Ring – con arillo – med ring

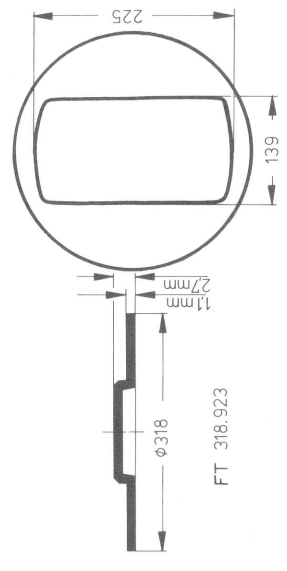
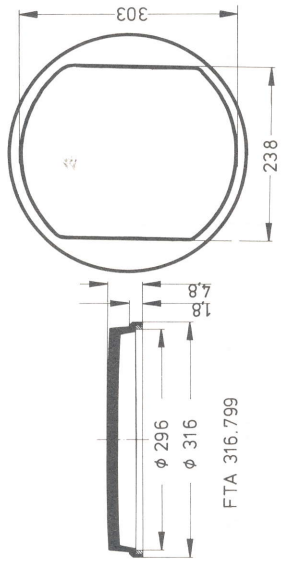
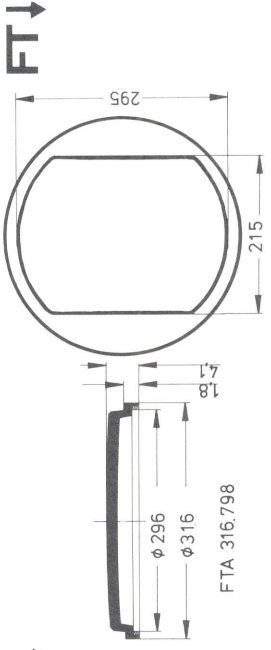
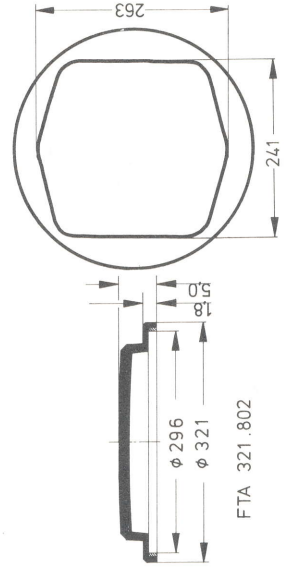
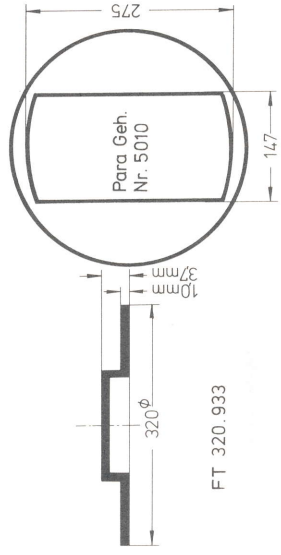
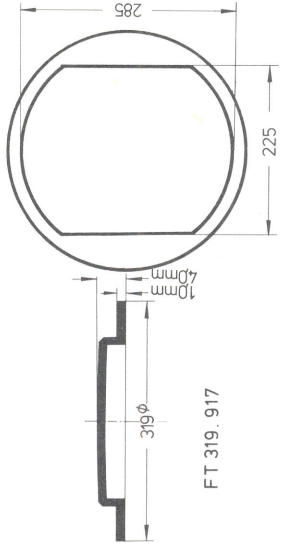

FT ↓

→

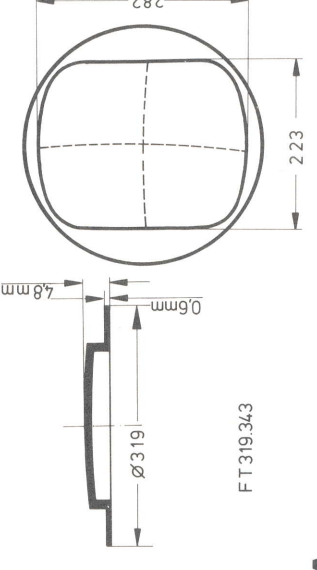
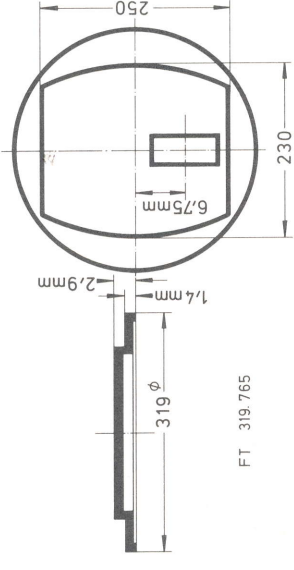
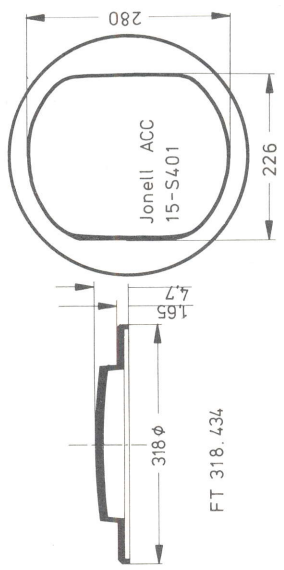
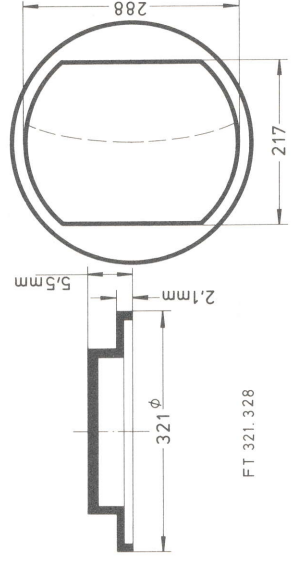
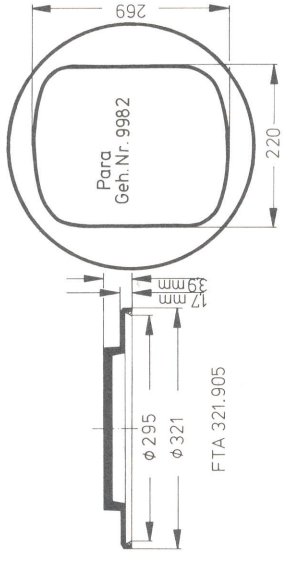
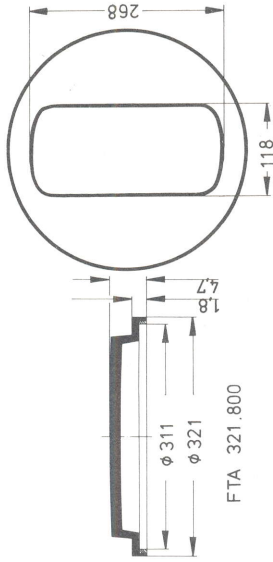

A = with ring – avec bague – mit Ring – con anillo – med ring

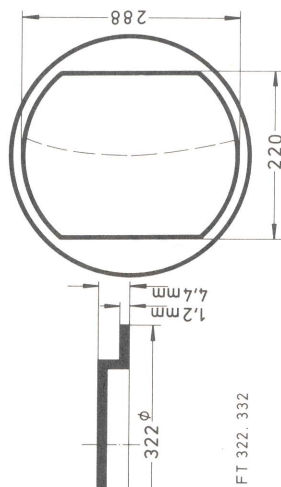
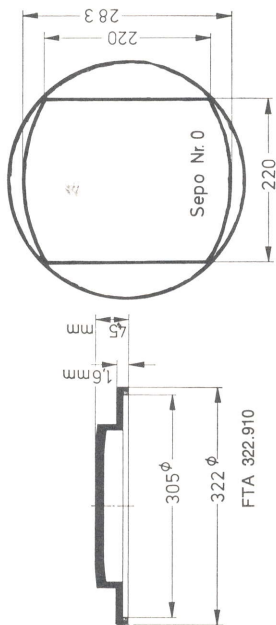
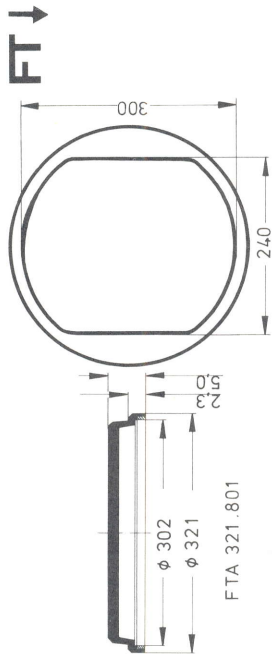
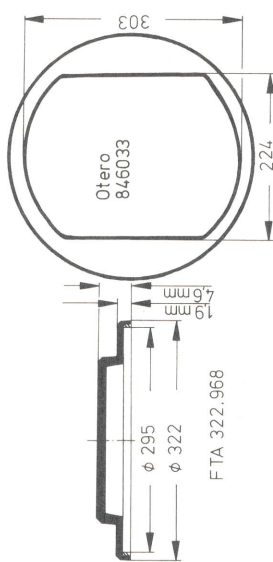
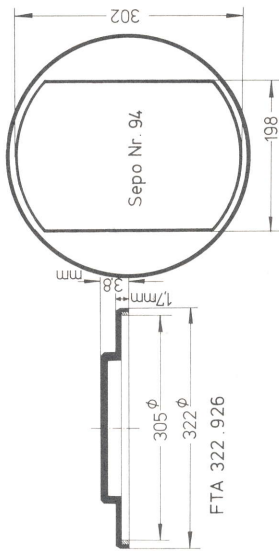
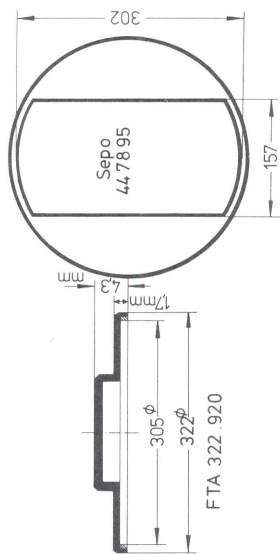

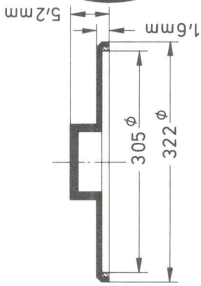
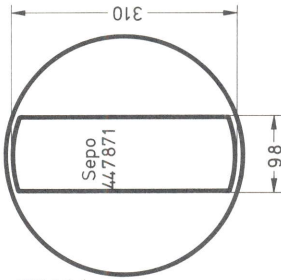

FTA 322.952

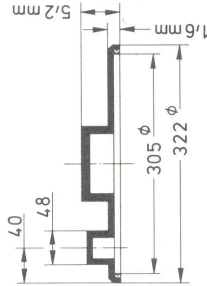
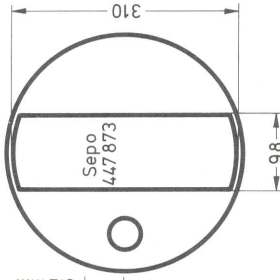

FTA 322.956

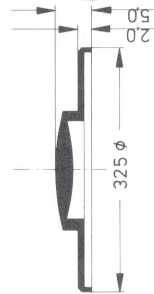
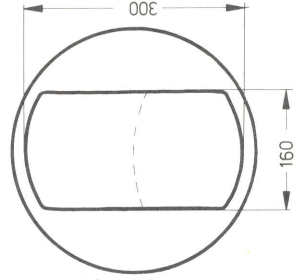

FT 325.419

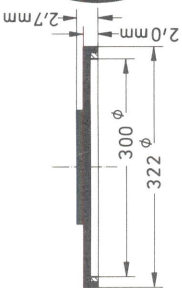
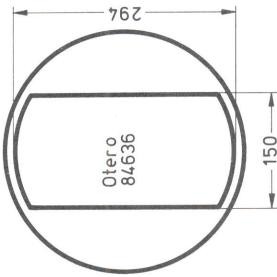

FTA 322.940

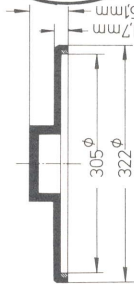
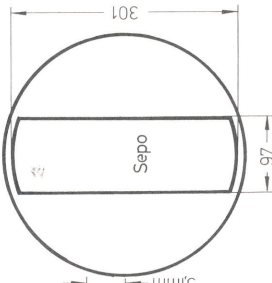

FTA 322.929

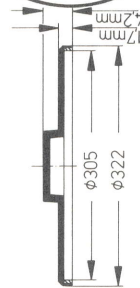
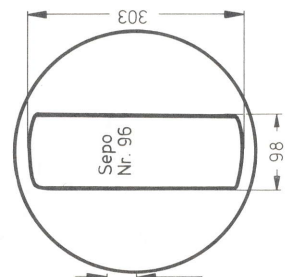

FTA 322.928

A = with ring – avec bague – mit Ring – con arillo – med ring

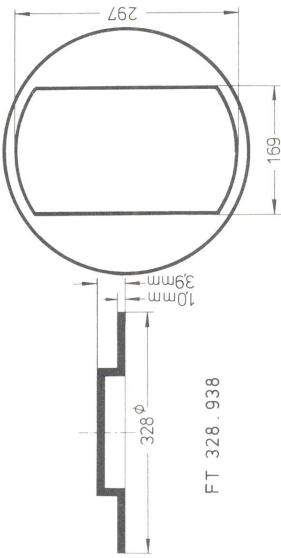

FT 328.938

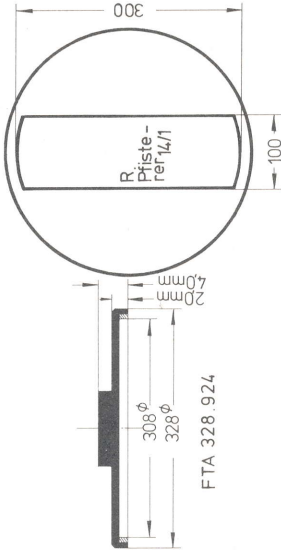

FTA 328.924

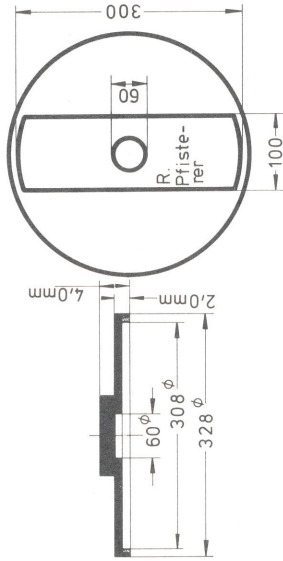

FTA 328.962

FT ↓

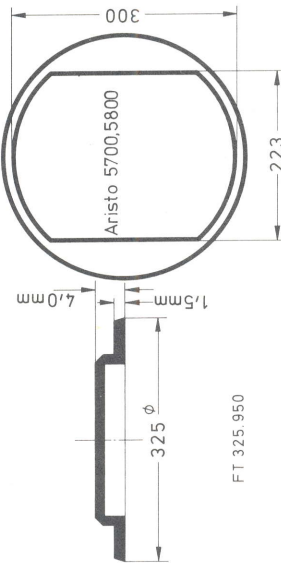

FT 325.950

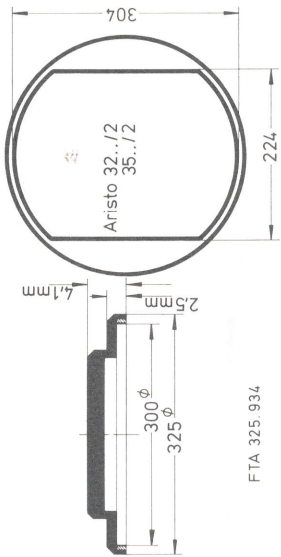

FTA 325.934

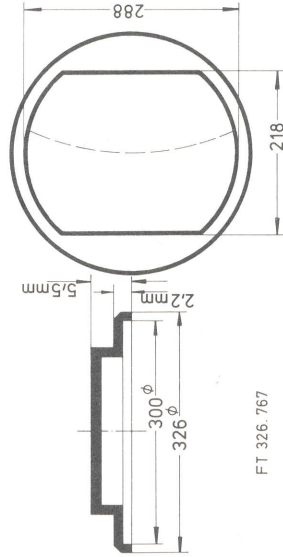

FT 326.767

↑

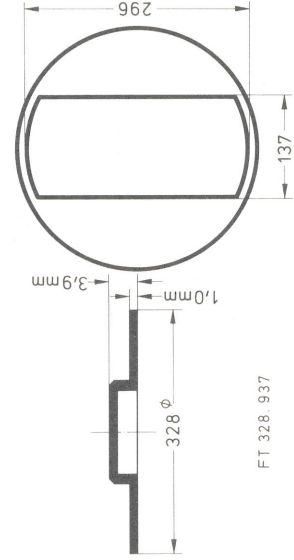
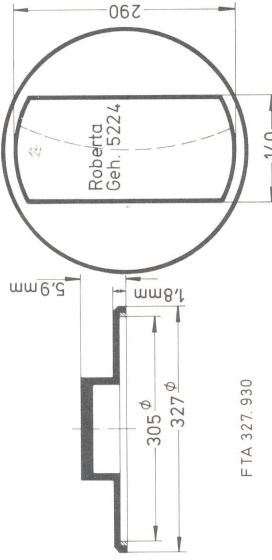
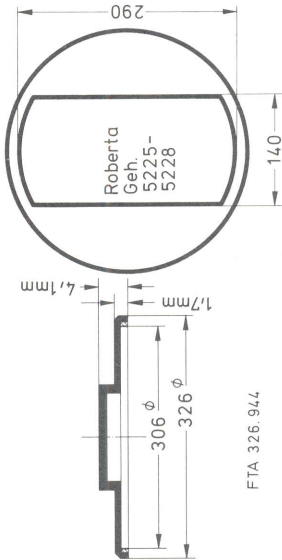
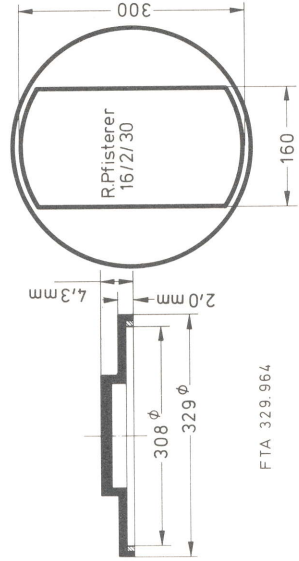
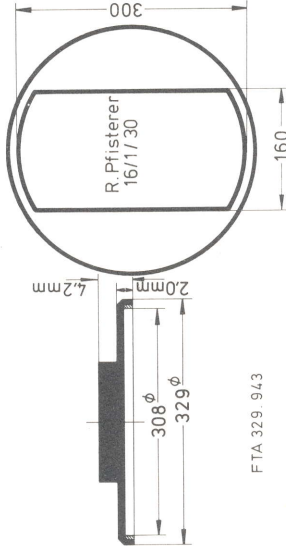
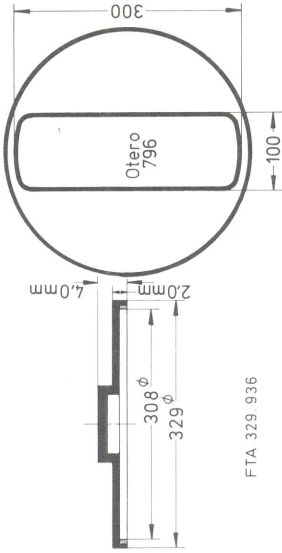

A = with ring – avec bague – mit Ring – con arillo – med ring

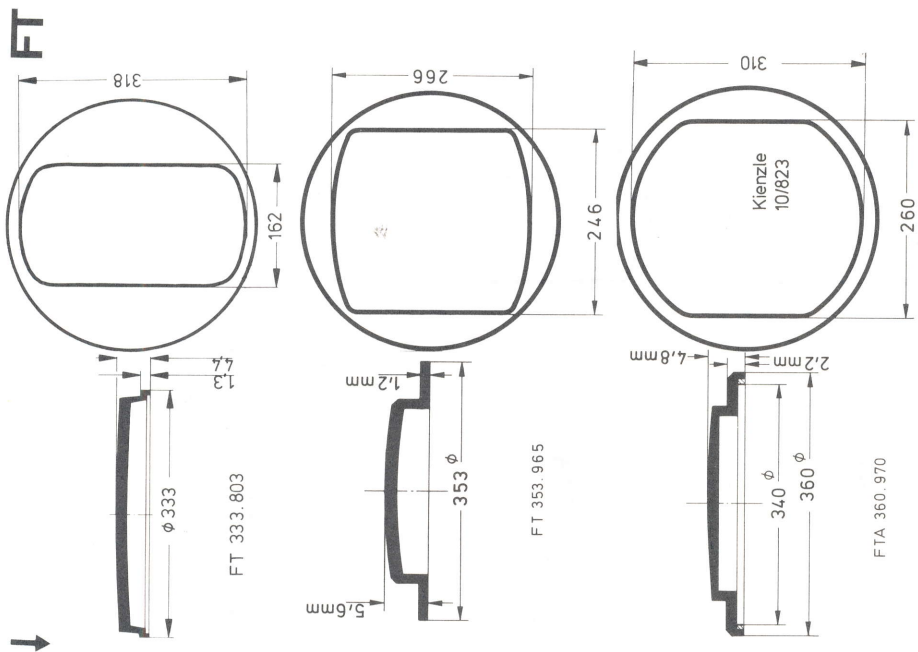

Some forms of glasses, which are to classify with difficulties, are illustrated twice, but always under one designation.

Quelques formes de verres, qui sont difficilement à classer, ont été représentées deux fois, mais toujours sous la même désignation.

Einige Glasformen, die schwer einzuordnen sind, wurden zweimal abgebildet, aber immer nur mit einer Bezeichnung.

Algunas de las formas de cristales difíciles a clasificar fueron representadas dos veces, pero siempre con una sola designación.

Vissa glas är svåra att formbestämna, varför de kan avbildas på olika sätt, men alltid samma beteckning.

FB ↓

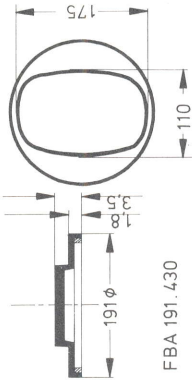

FBA 191.430

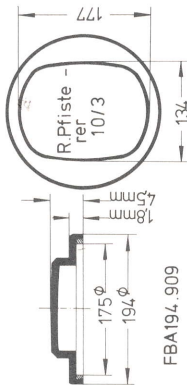

FBA 194.909

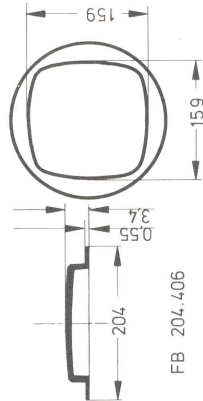

FB 204.406

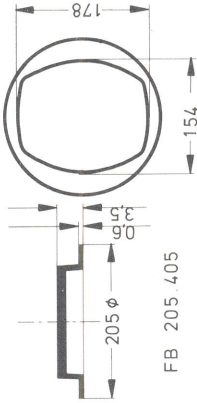

FB 205.405

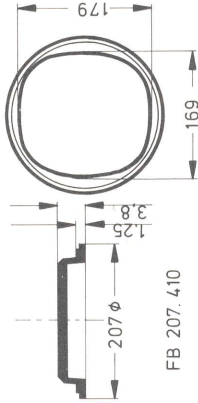

FB 207.410

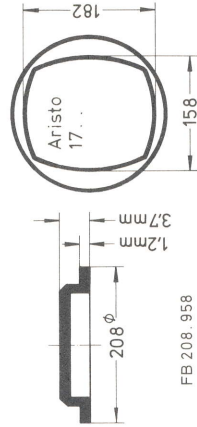

FB 208.958

↓

A = with ring – avec bague – mit Ring – con arillo – med ring

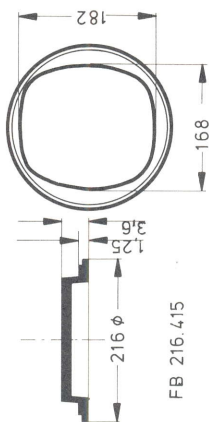

FB 216.415

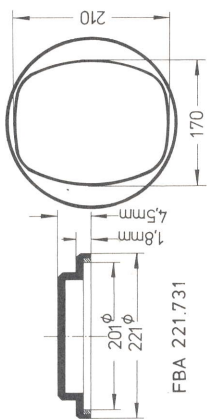

FBA 221.731

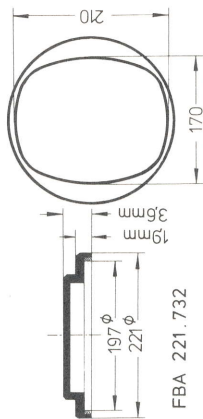

FBA 221.732

FB ↓

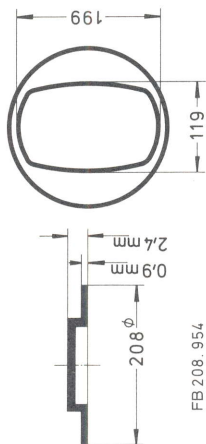

FB 208.954

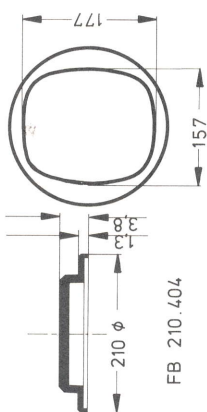

FB 210.404

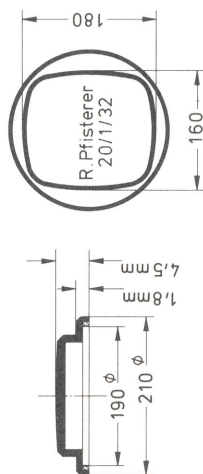

FBA 210.951



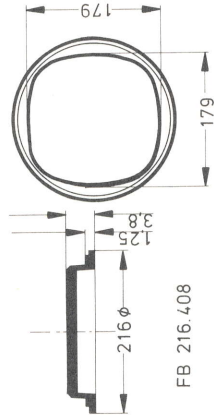
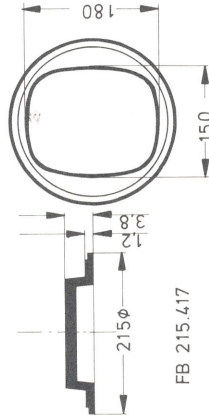
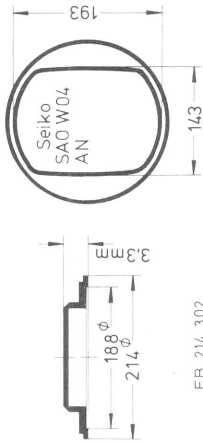
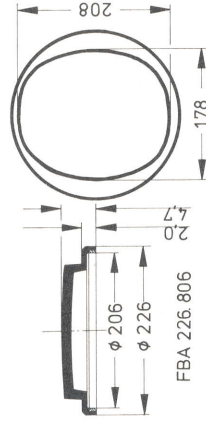
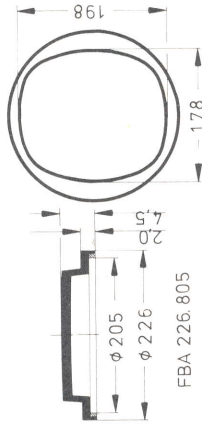
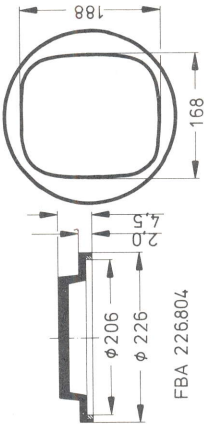

A = with ring – avec bague – mit Ring – con arillo – med ring

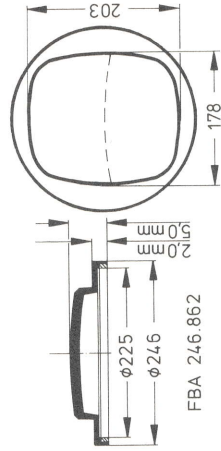
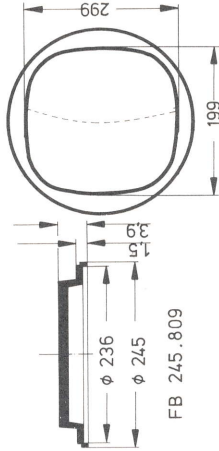
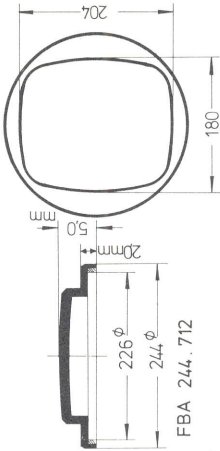

FB ↓

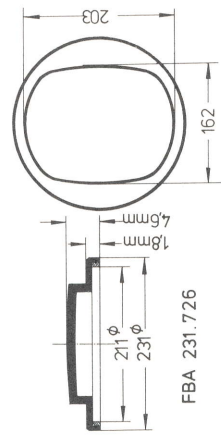
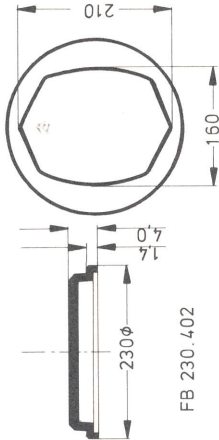
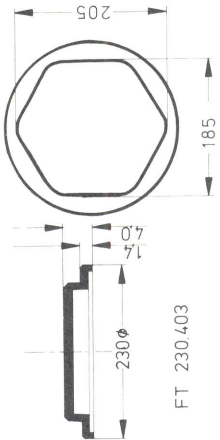

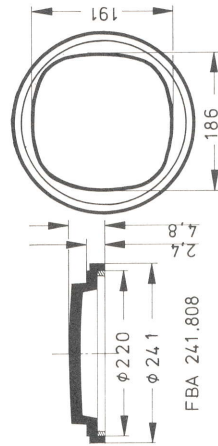
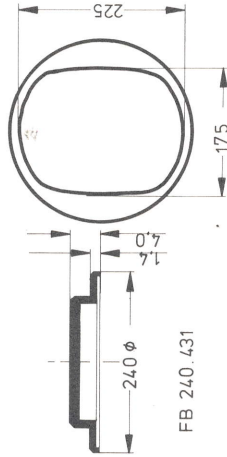
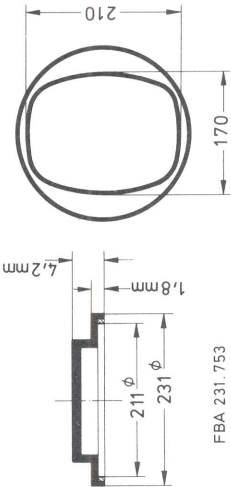
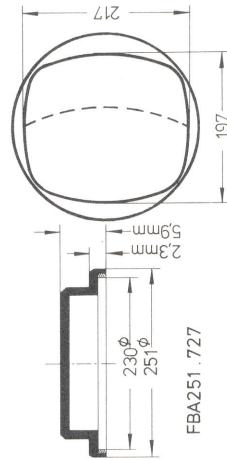
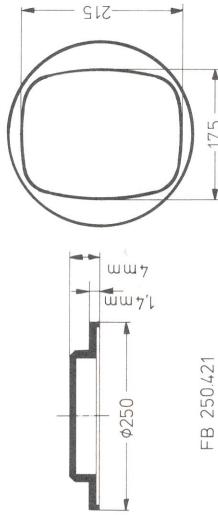
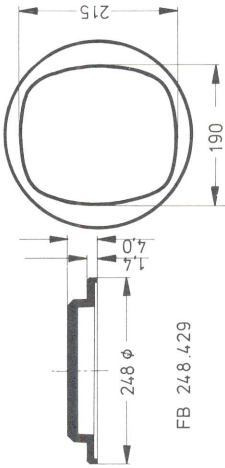

A = with ring – avec bague – mit Ring – con arillo – med ring

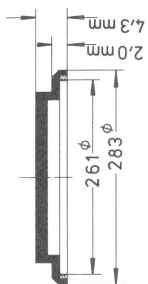
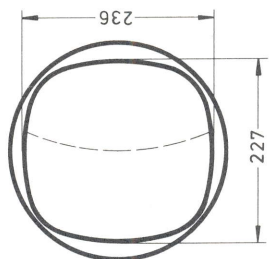

FBA 283.307

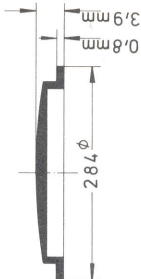
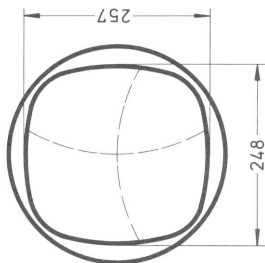

FB 284.309

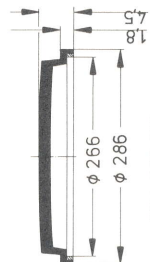
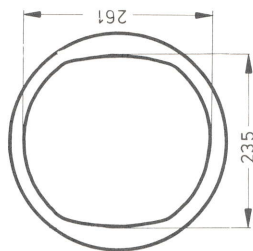

FBA 286.812

FB ↓

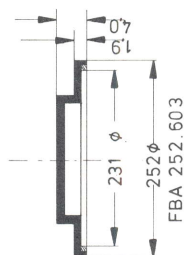
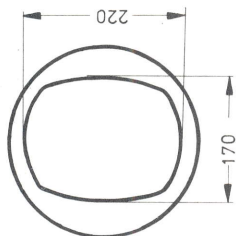

FBA 252.603

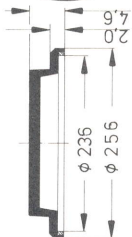
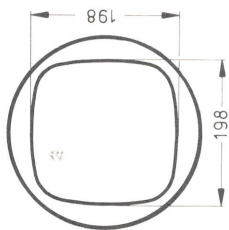

FBA 256.810

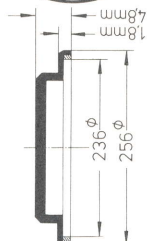
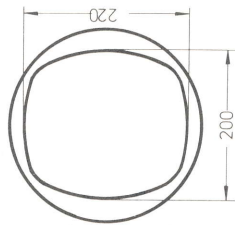

FBA 256.748

